



中

NCES

2

1

42

1

56

4

1.	1
2	2
3	
4	4
5	5
6	6
7.	
8	
9.	
10	11
11.	12
12	13
13	14
14	15
15.	16
16	17
17.	18

(%

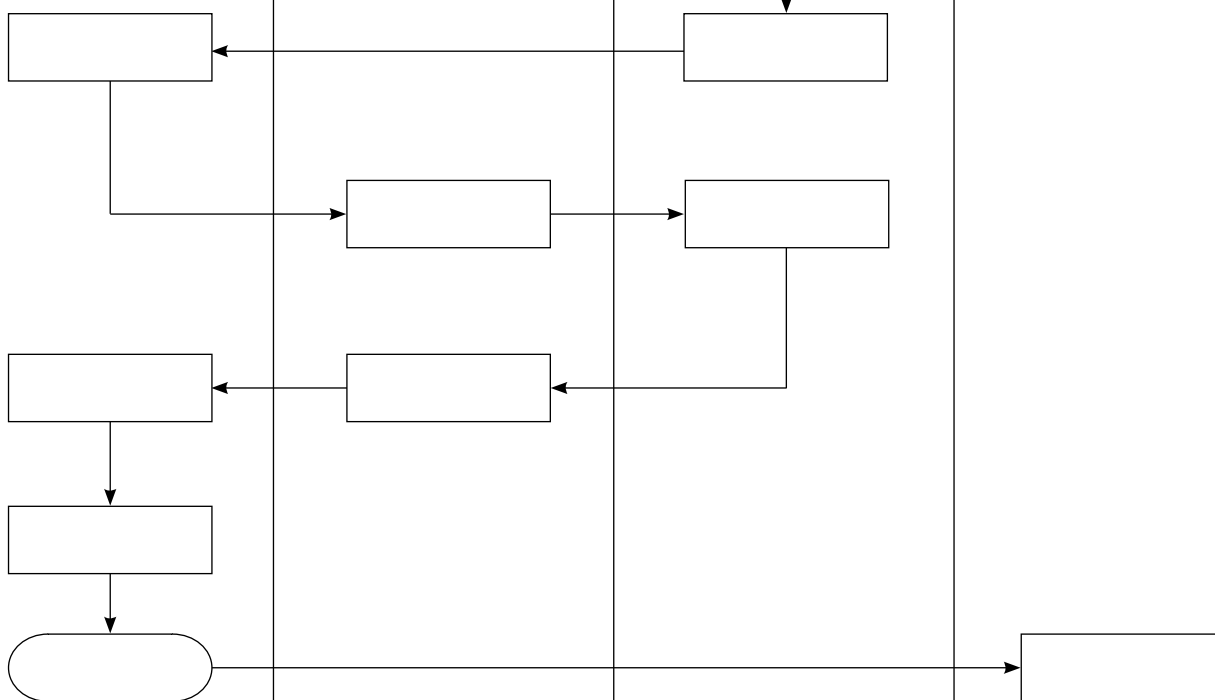
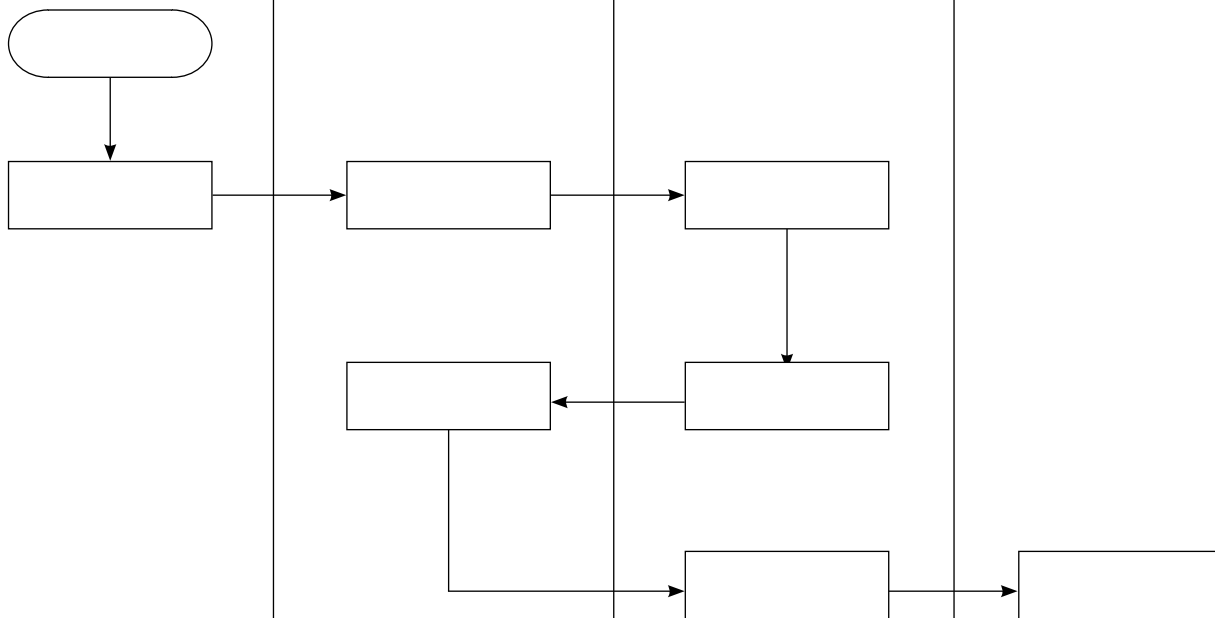

1.
2

)%

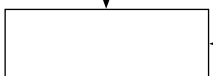
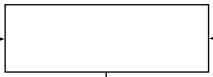
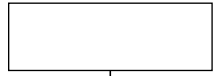
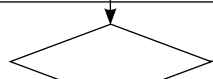
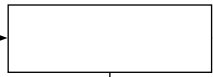
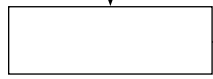
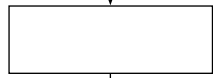

←

N

N

Y

N

Y

Y

N

Y

N

Y

Y

- 1.
- 2.
- 3.
- 4.

* %

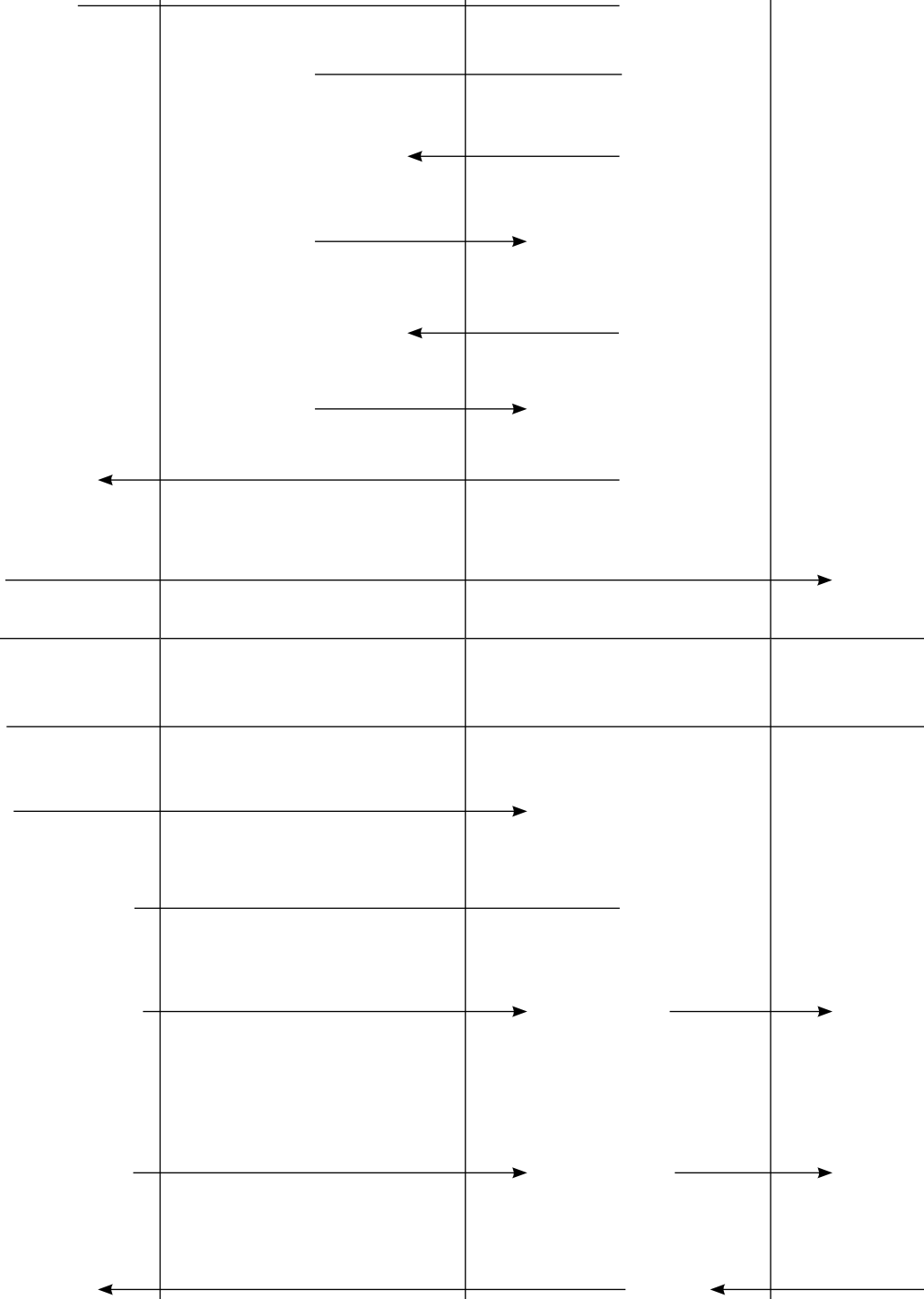

- 1.
- 2

+%

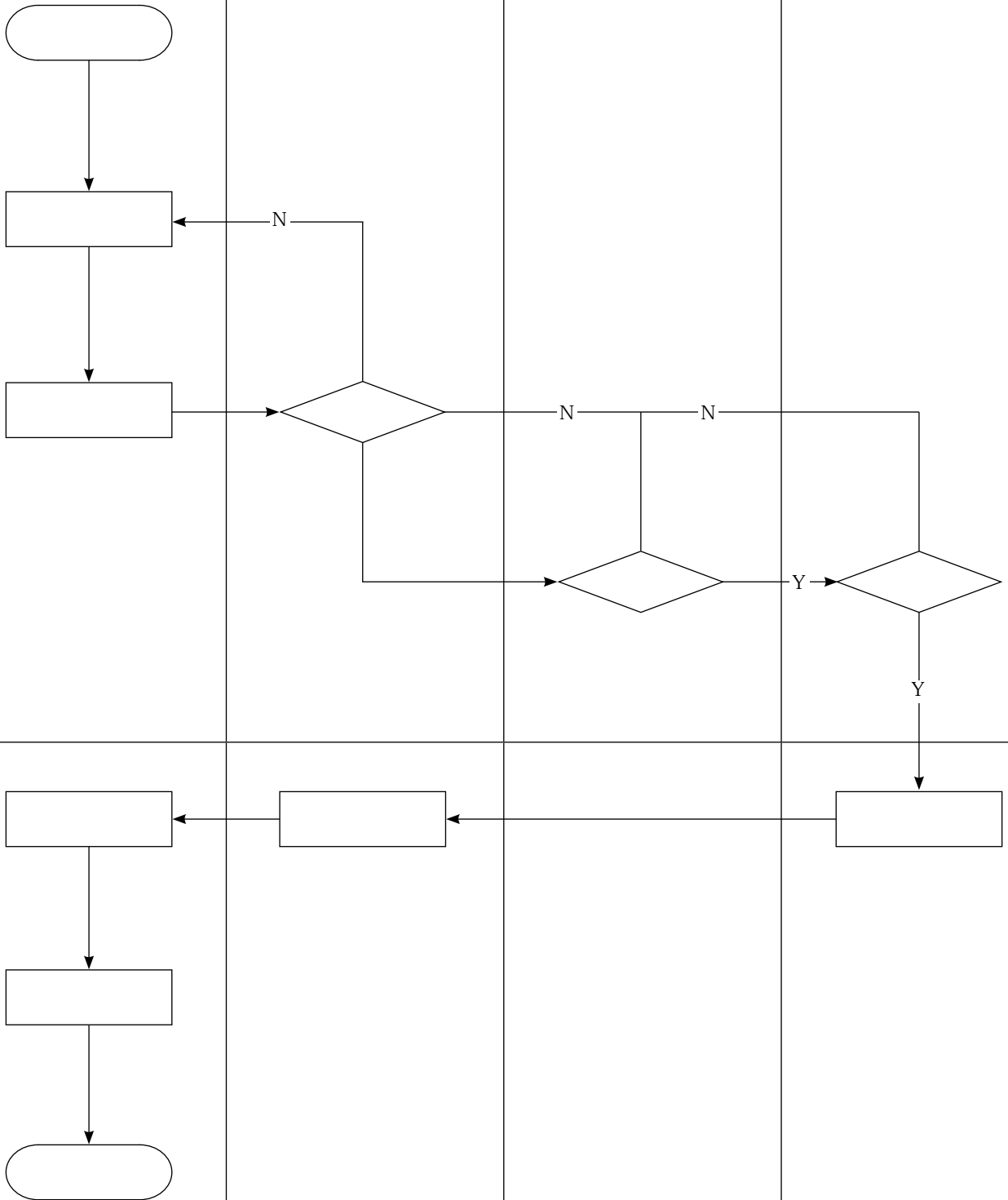

, %

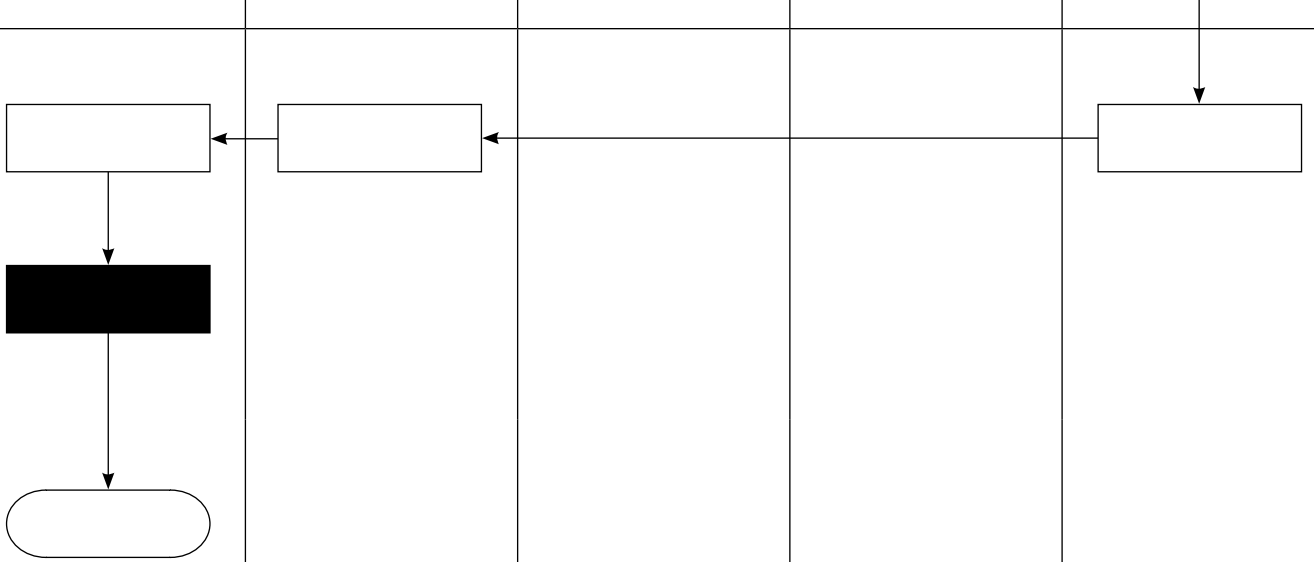
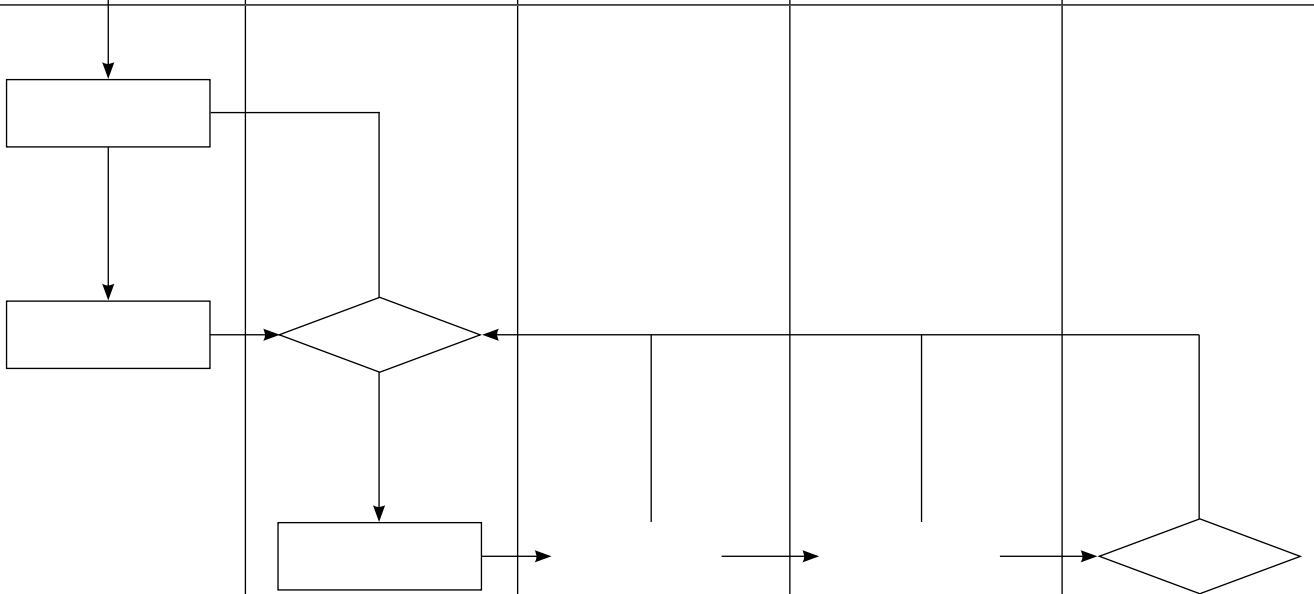
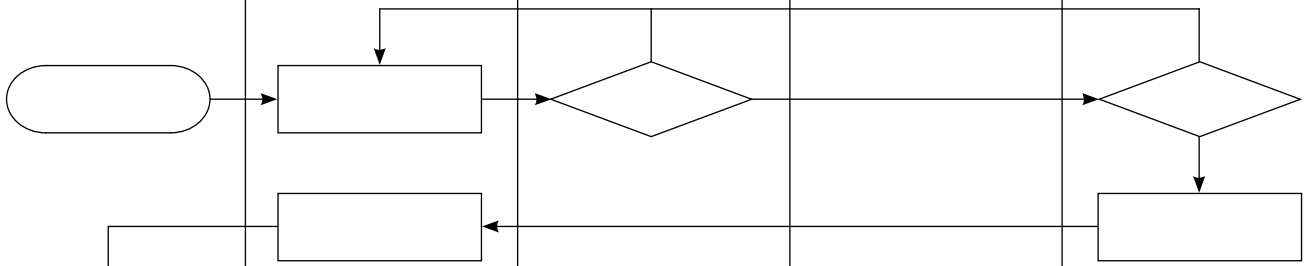

- %

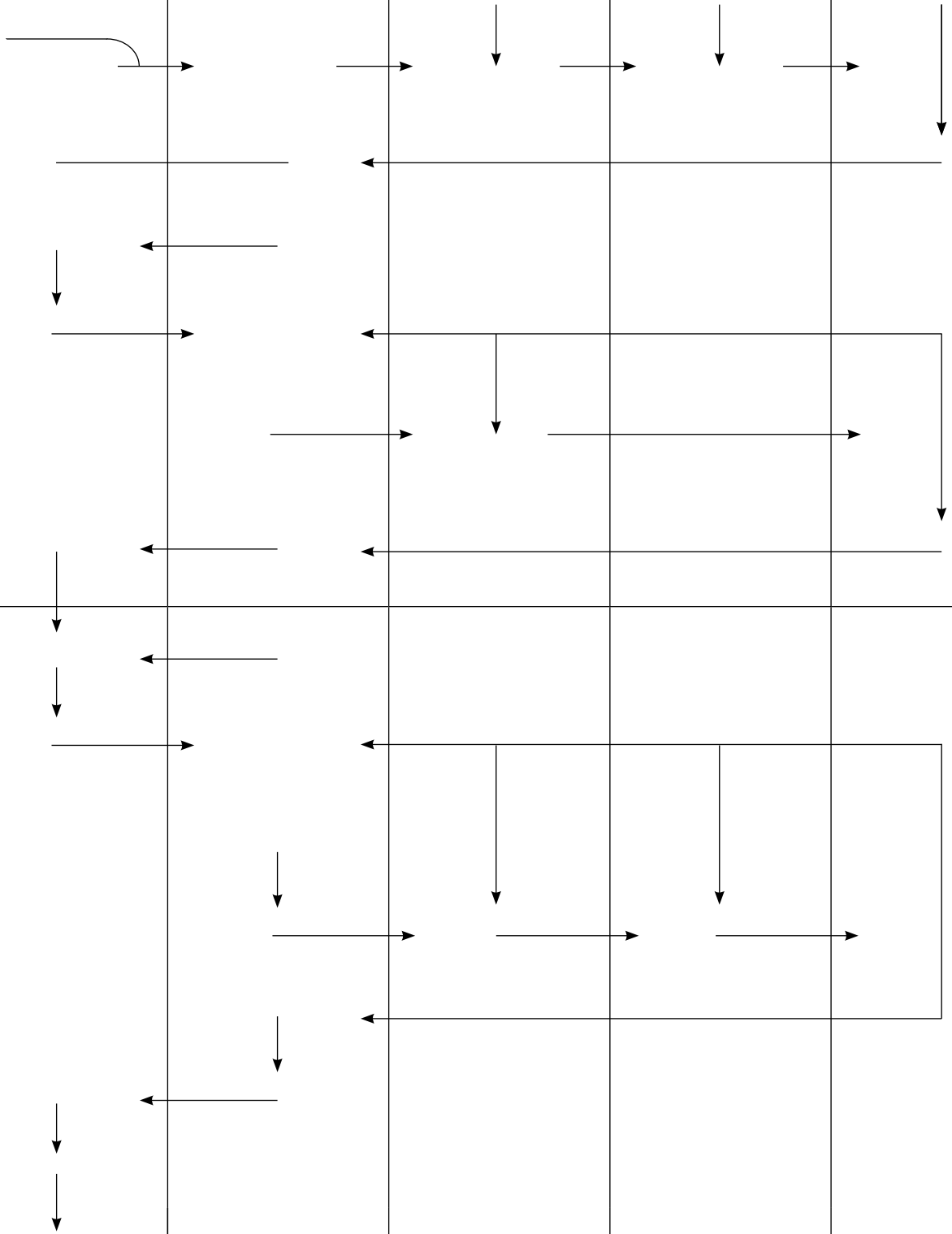

. %

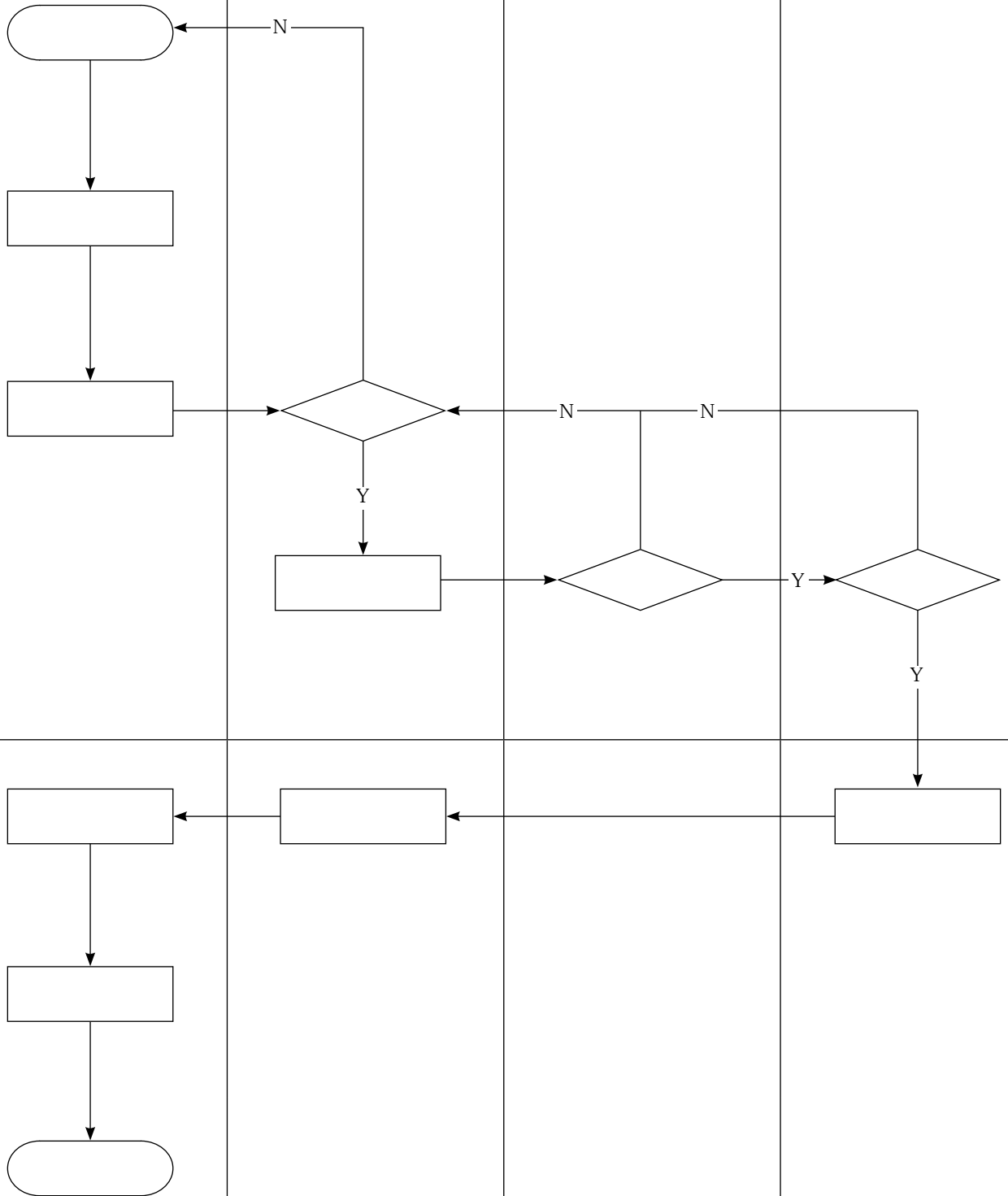

1%

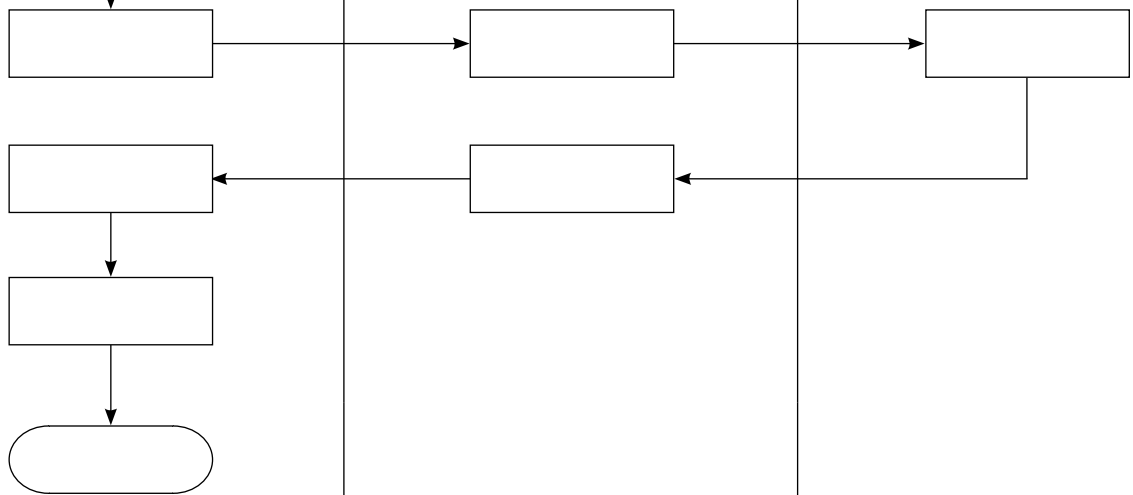
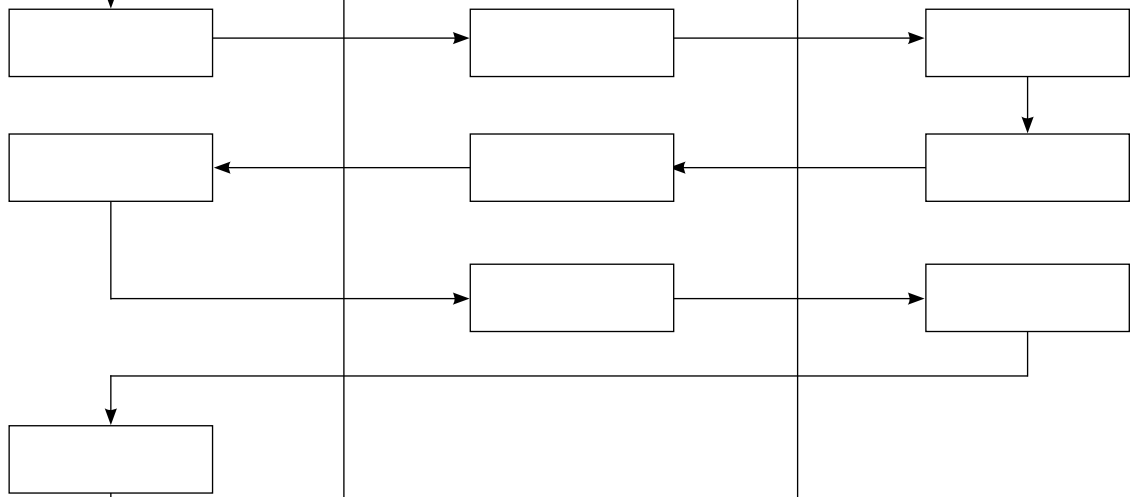
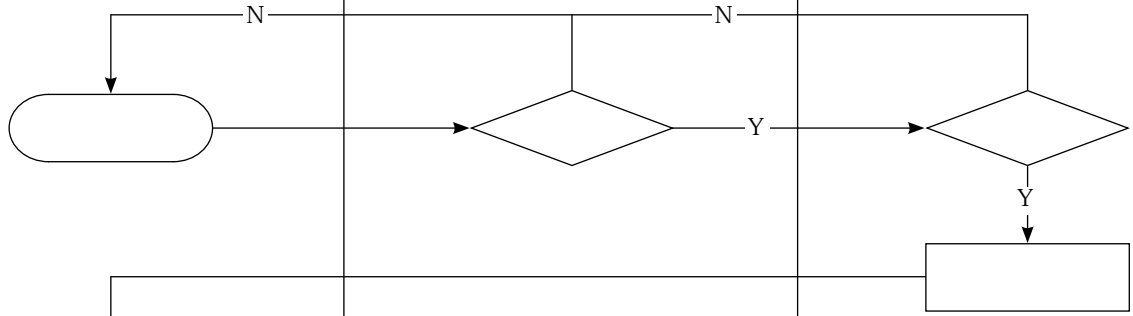

0%

Ž(ž

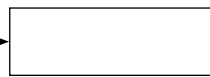
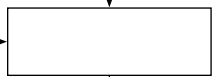
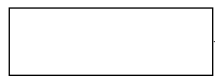
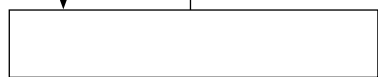
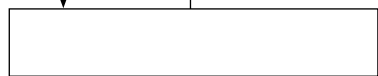
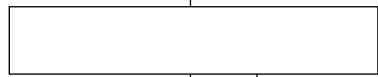
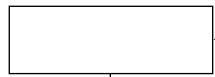
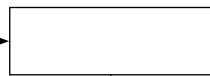
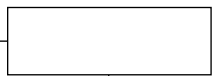
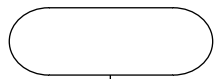

N

Y

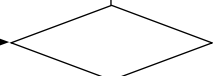

0%

ž ž

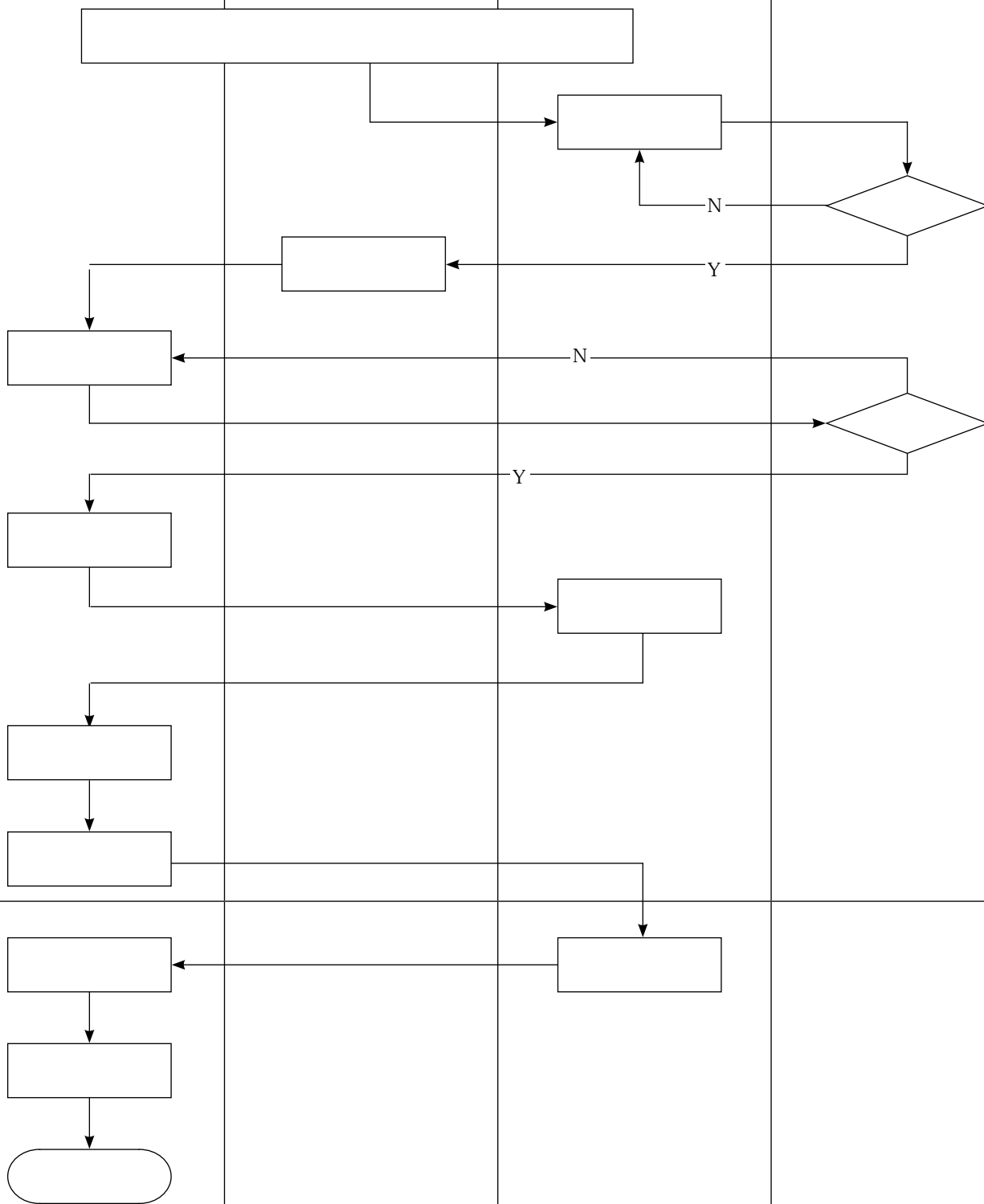

(' %

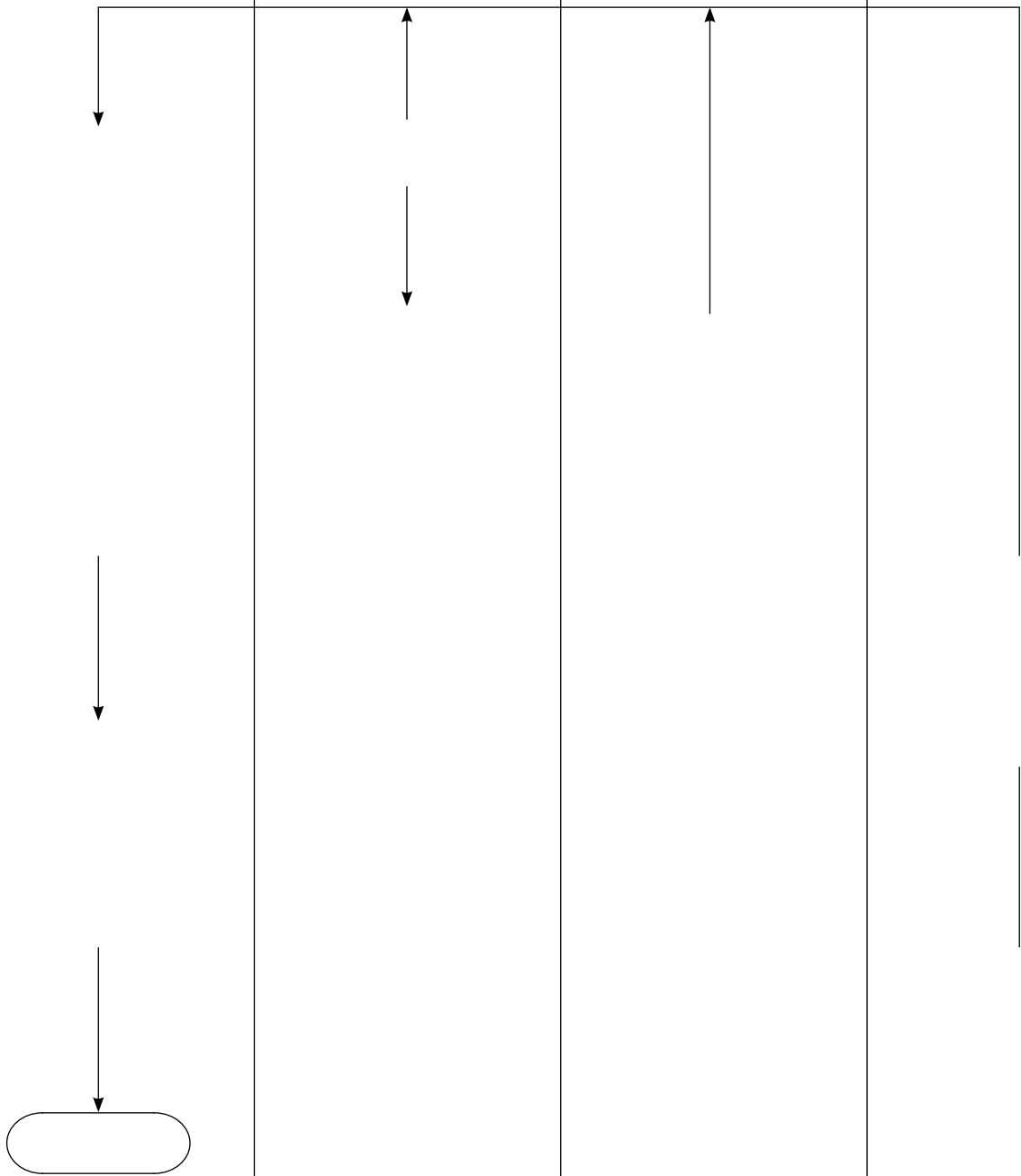

- 1
- 2
- 3
- 4

() %

- 1.
- 2
- 3

(* %

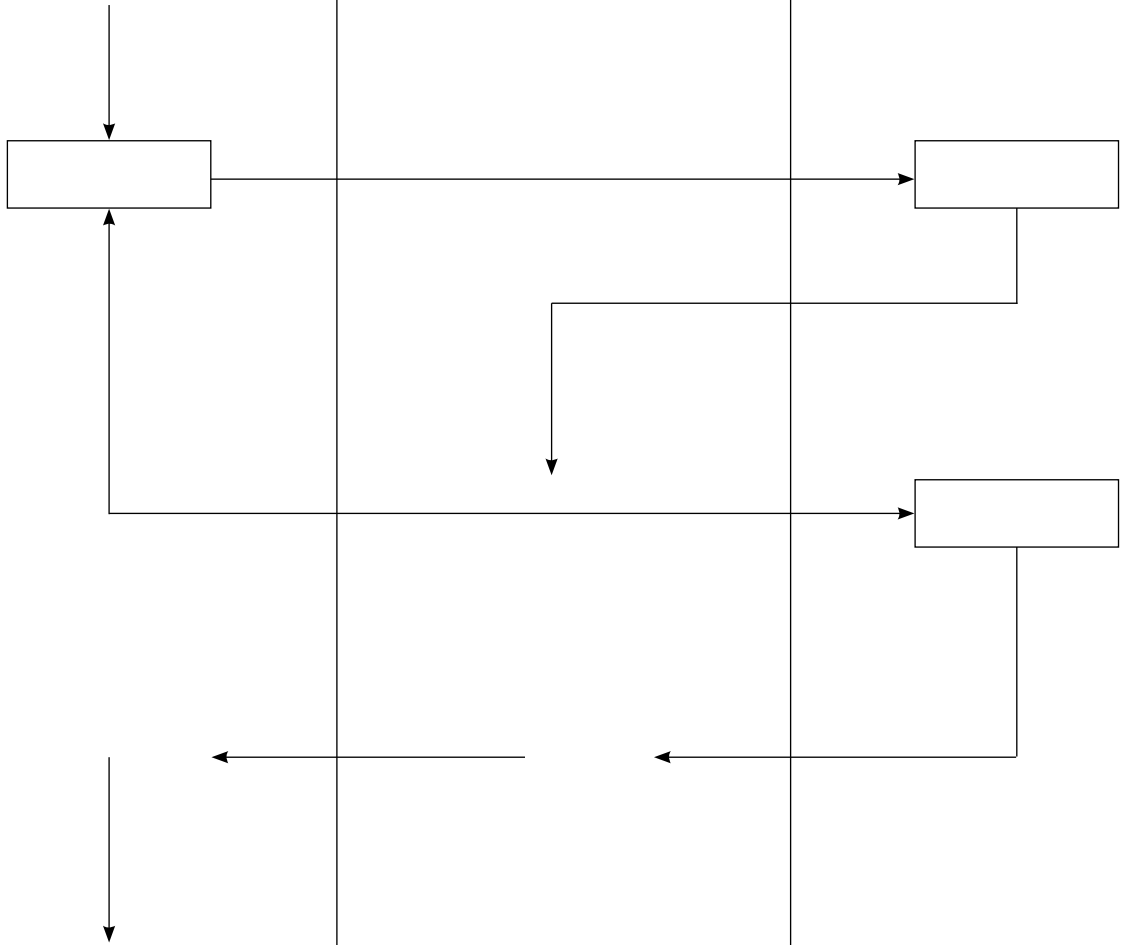

(, %

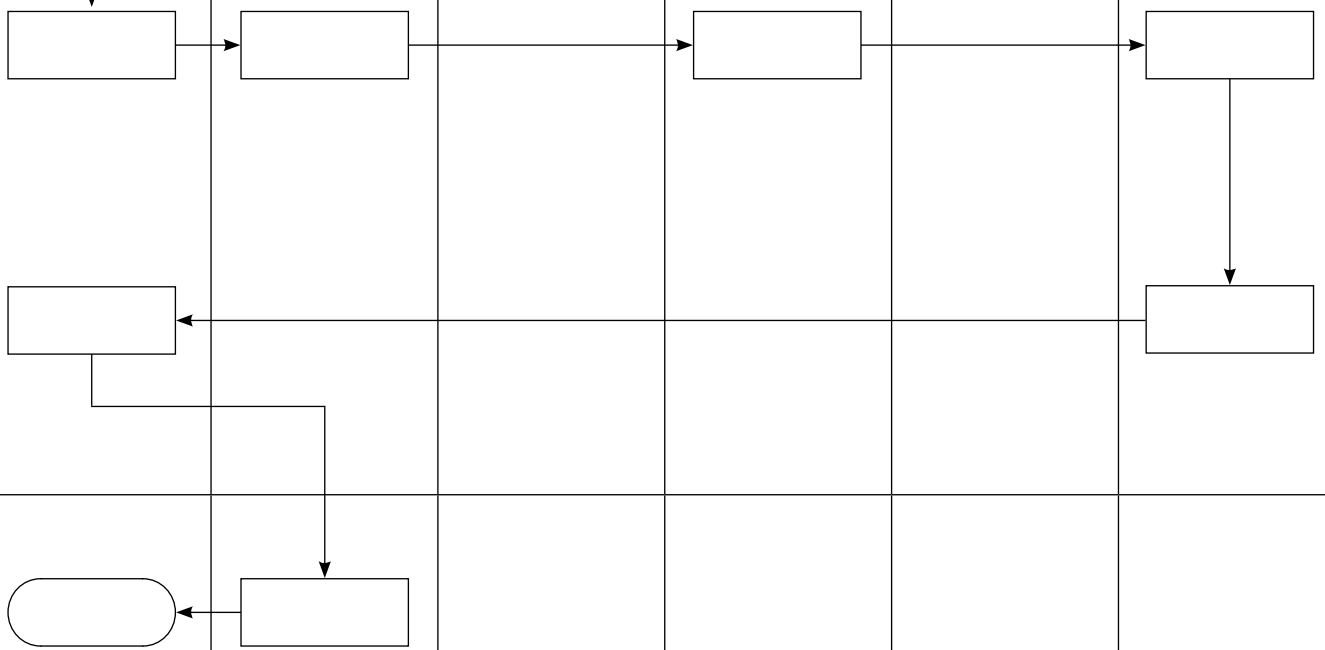
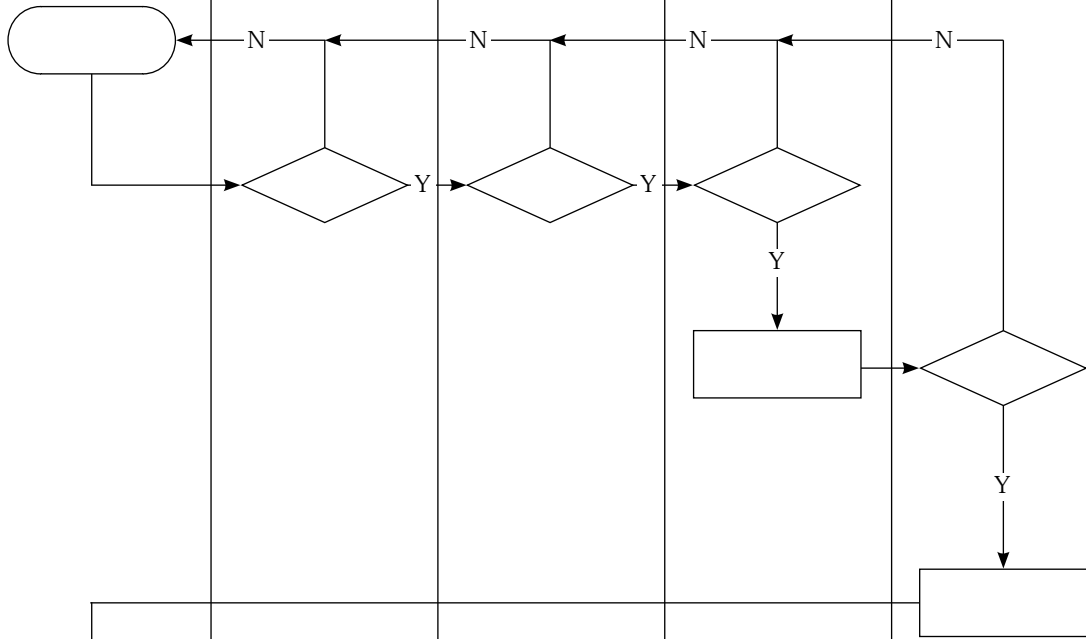

(- %

|

↓

|

↓

↓

|

|

|

|

↓

↓

(. %

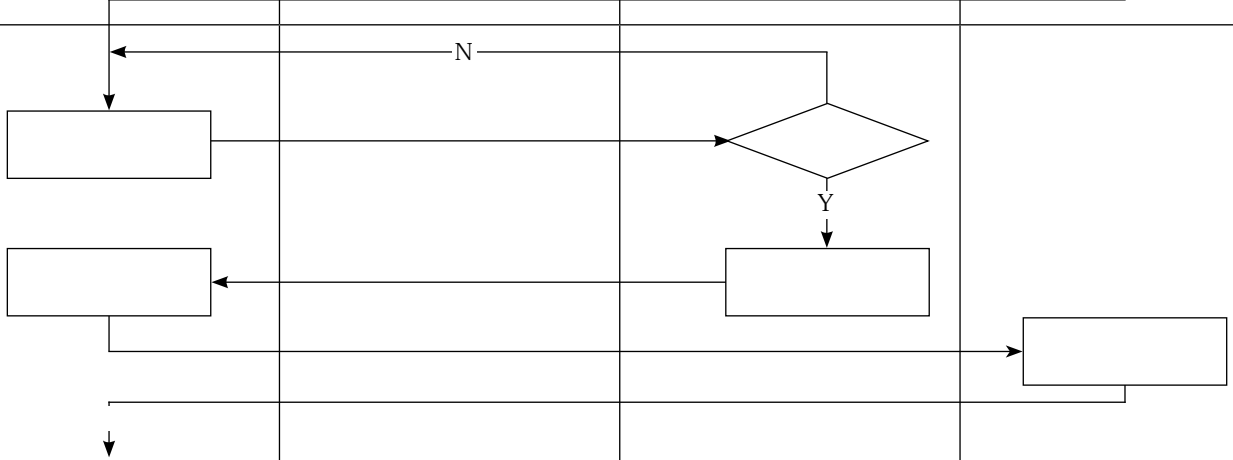
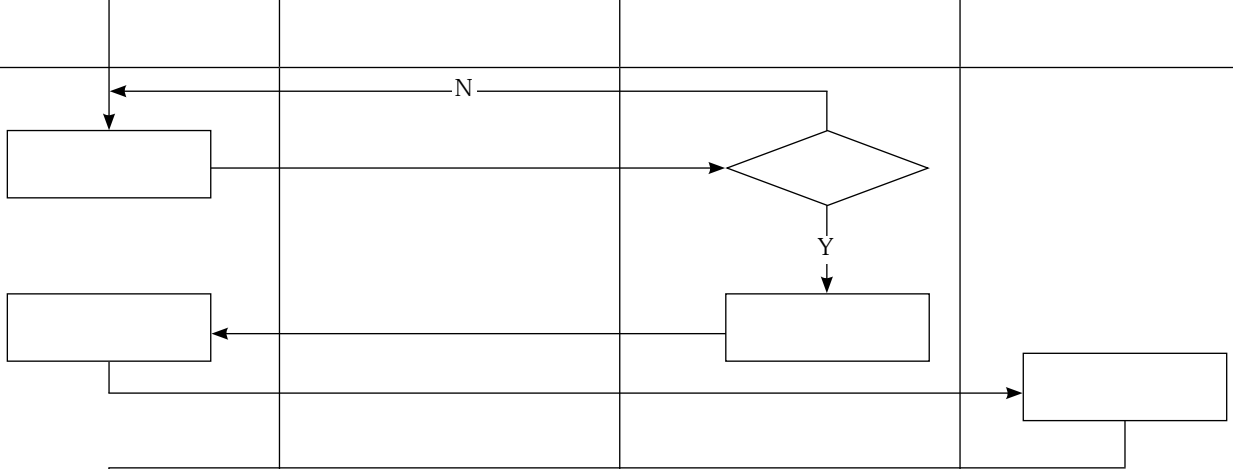
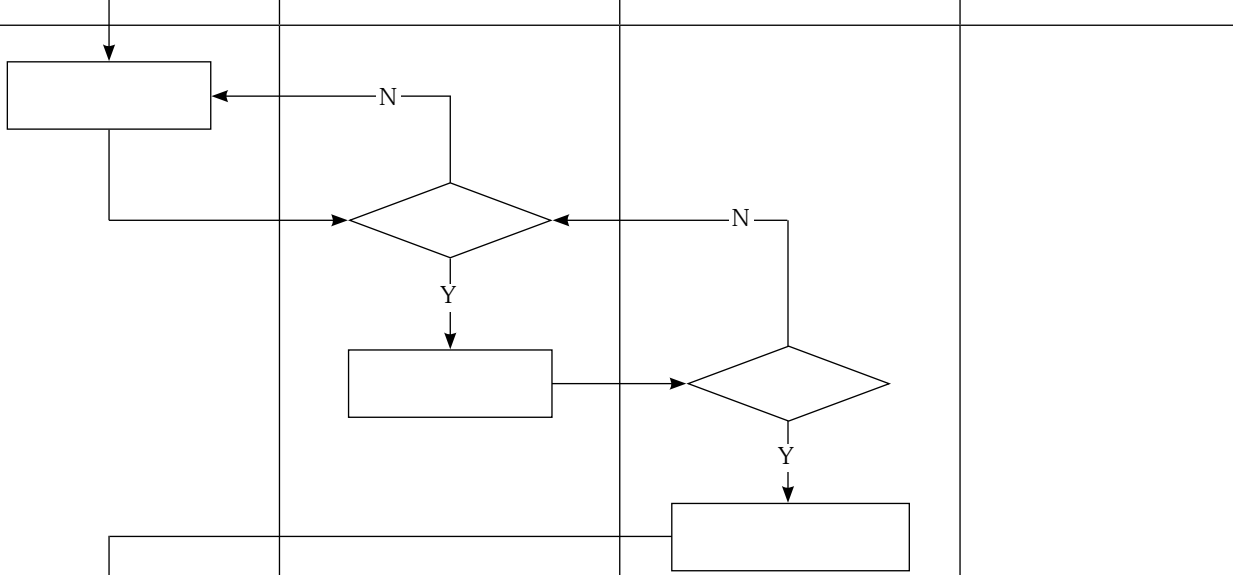
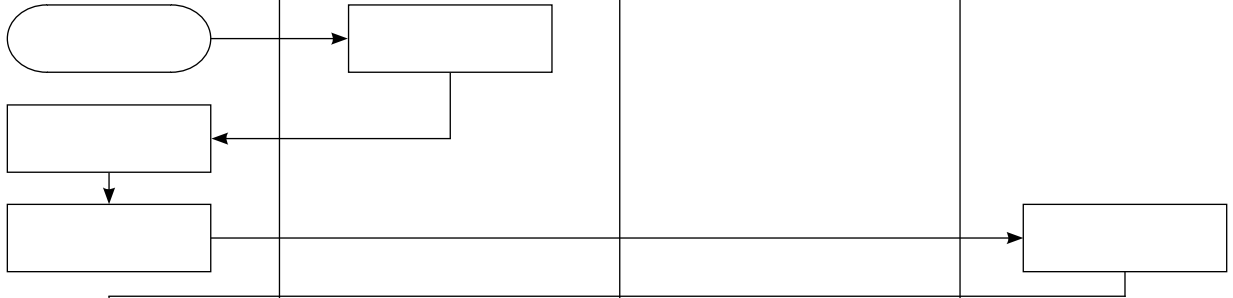

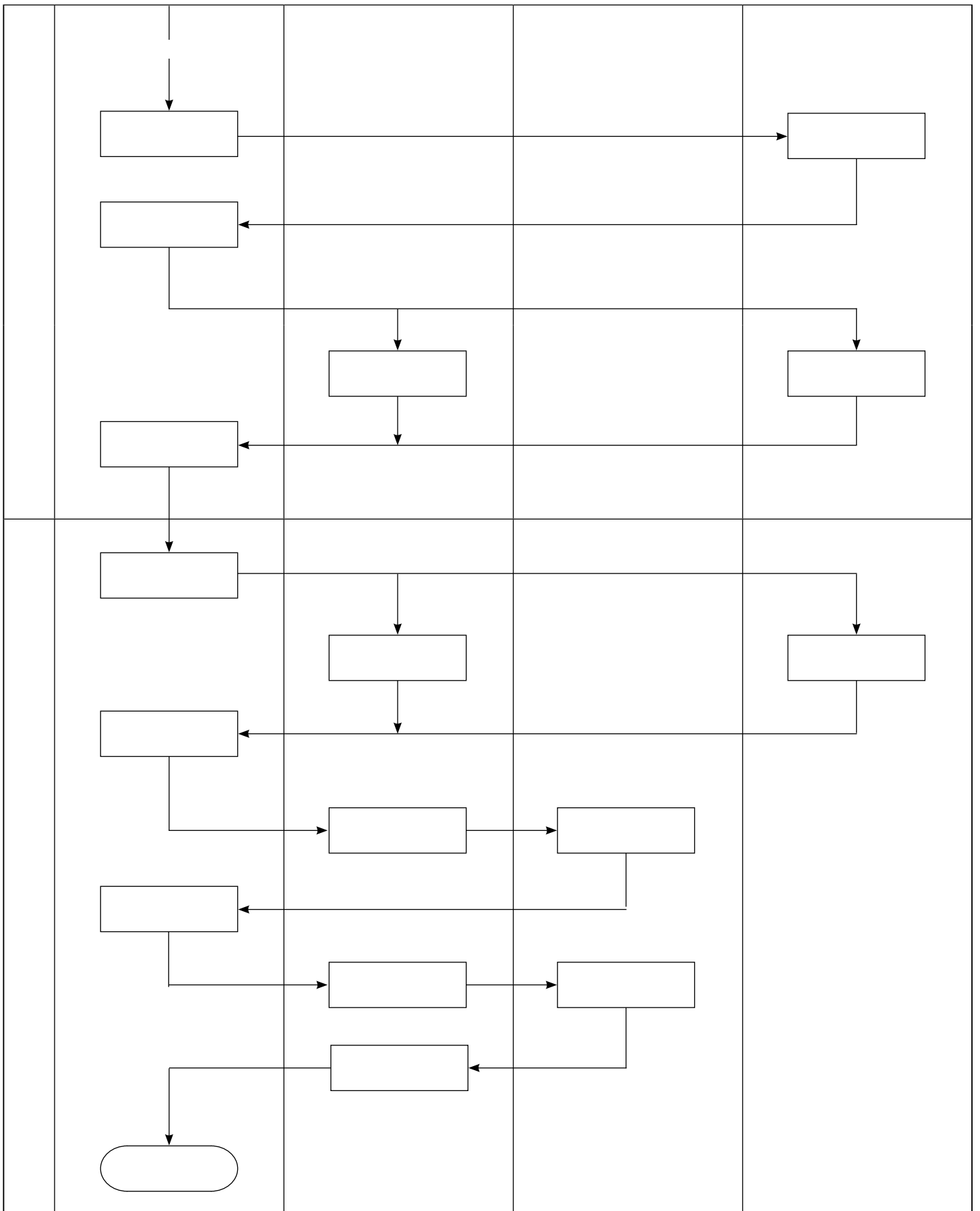

1.
2

(/%



- 1.
- 2.

- 1.
- 2.
- 3.

- 4.
- 5.

(0%

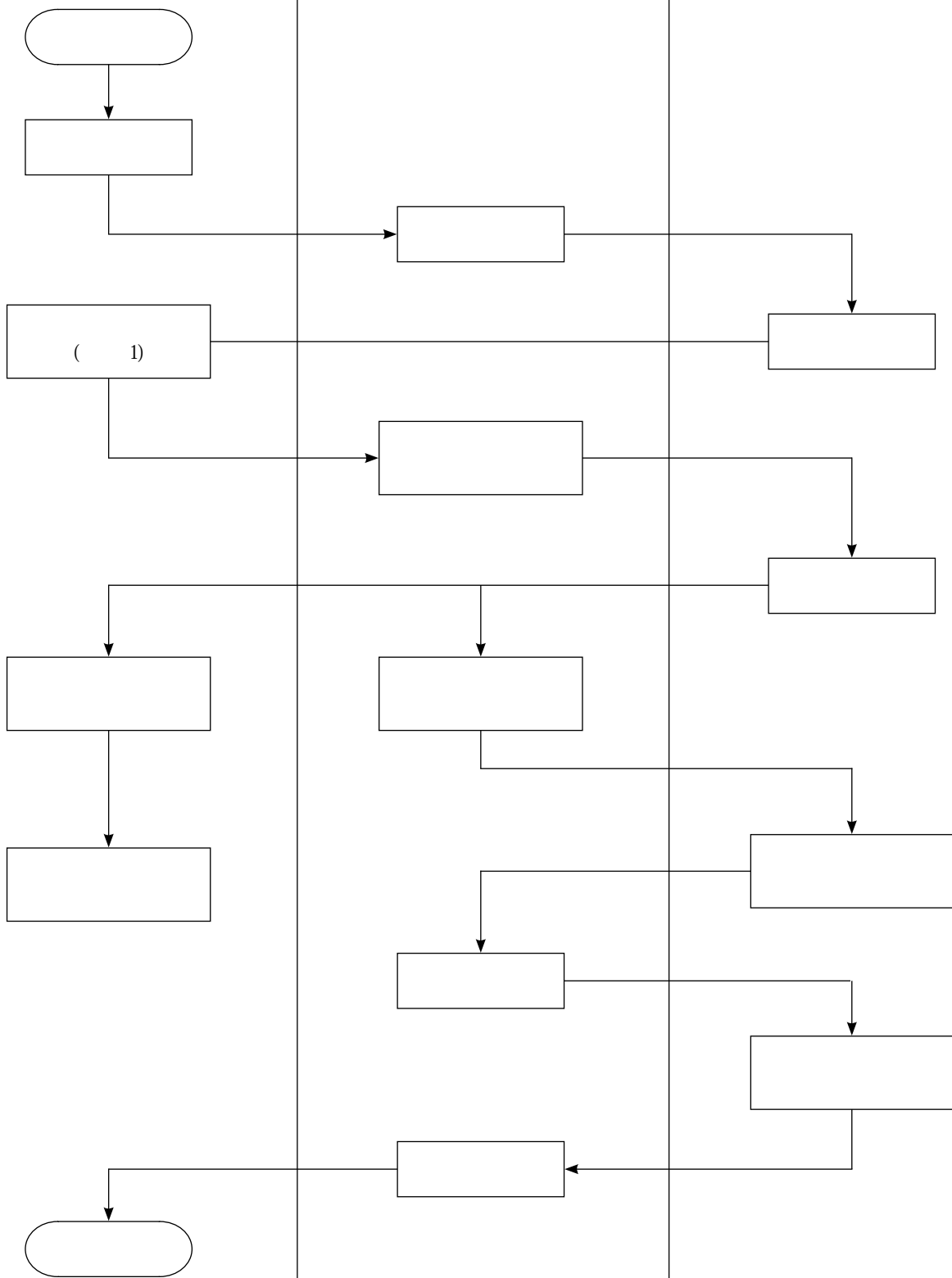

)(%

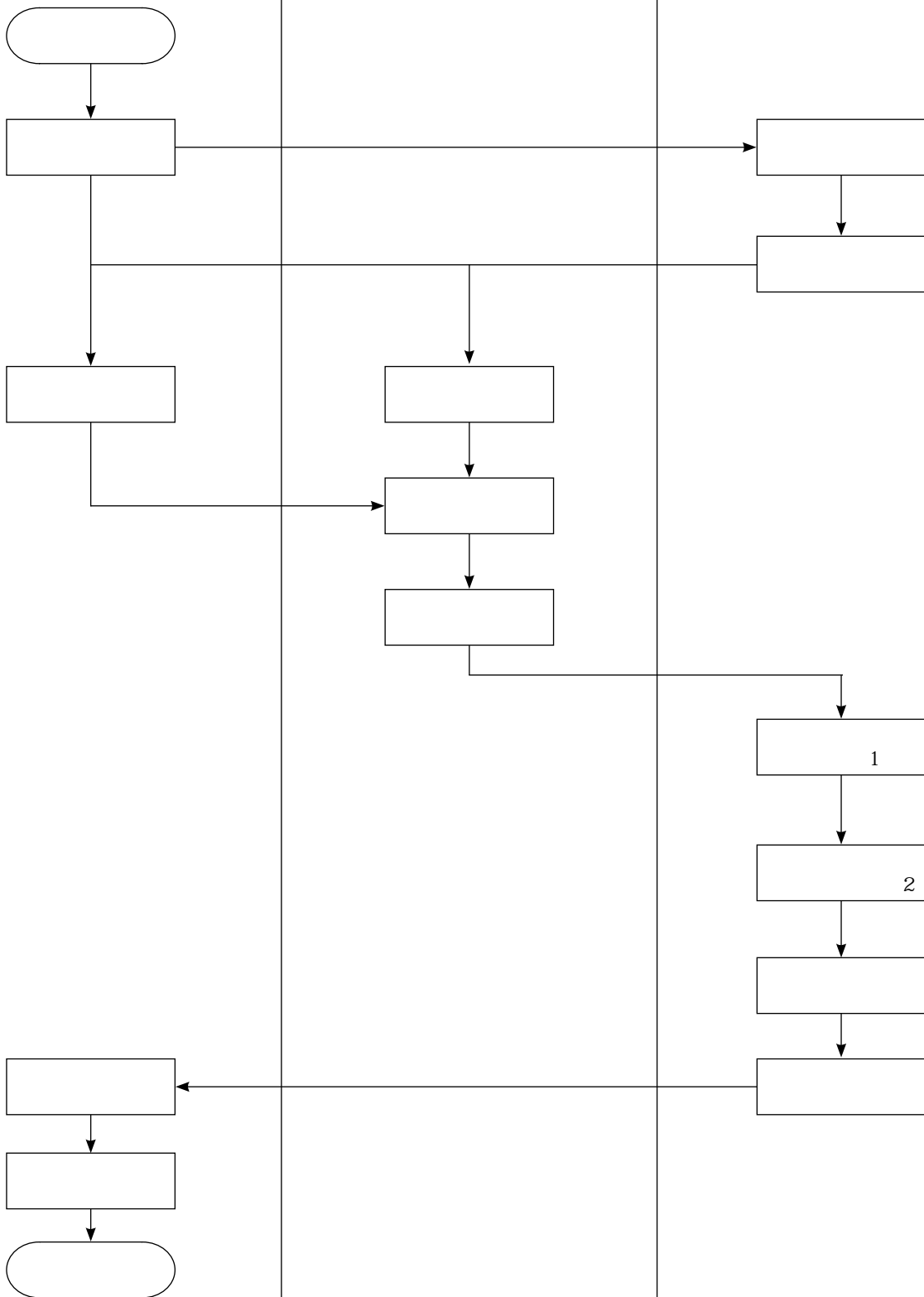

))%

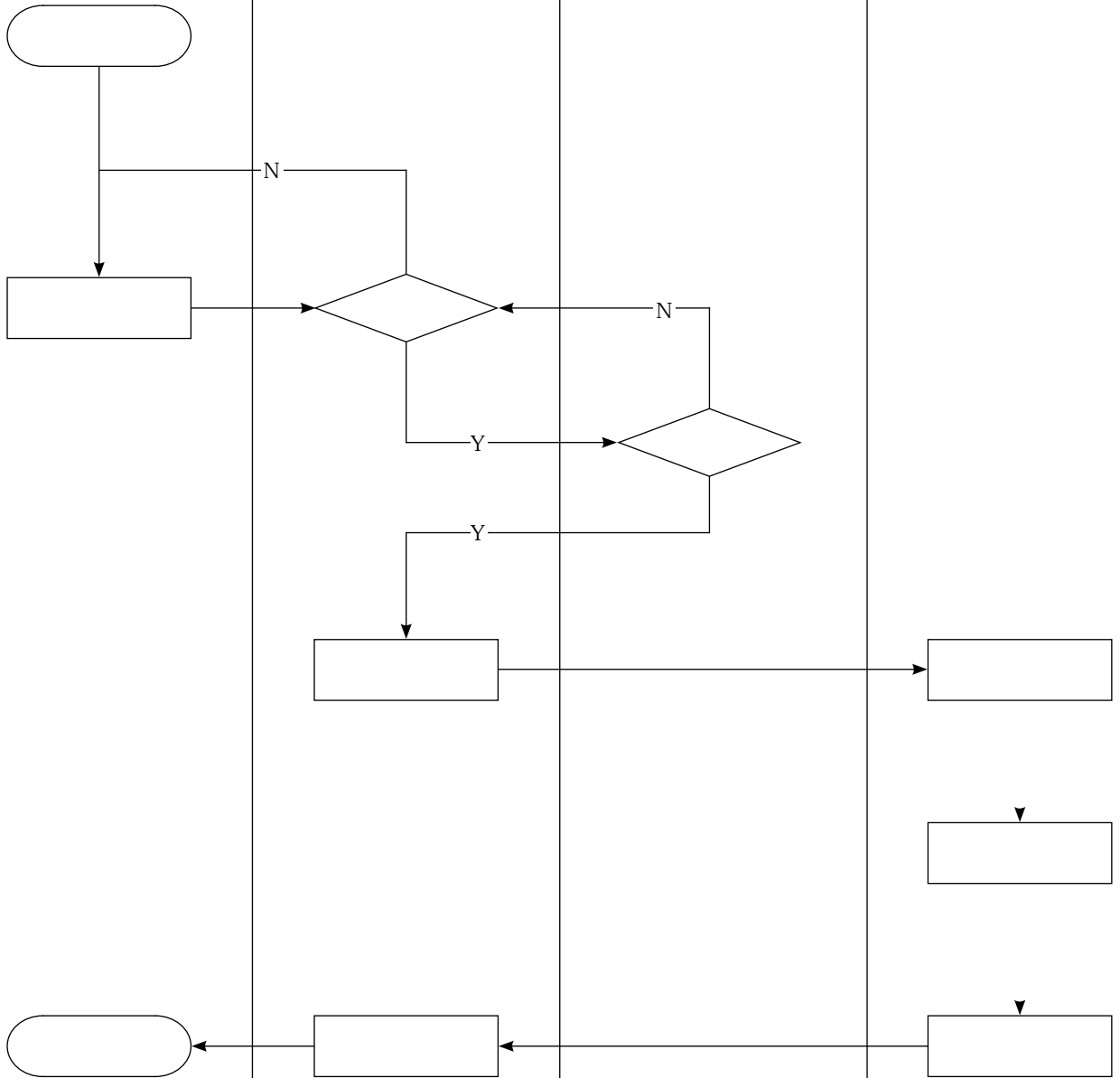

) * %

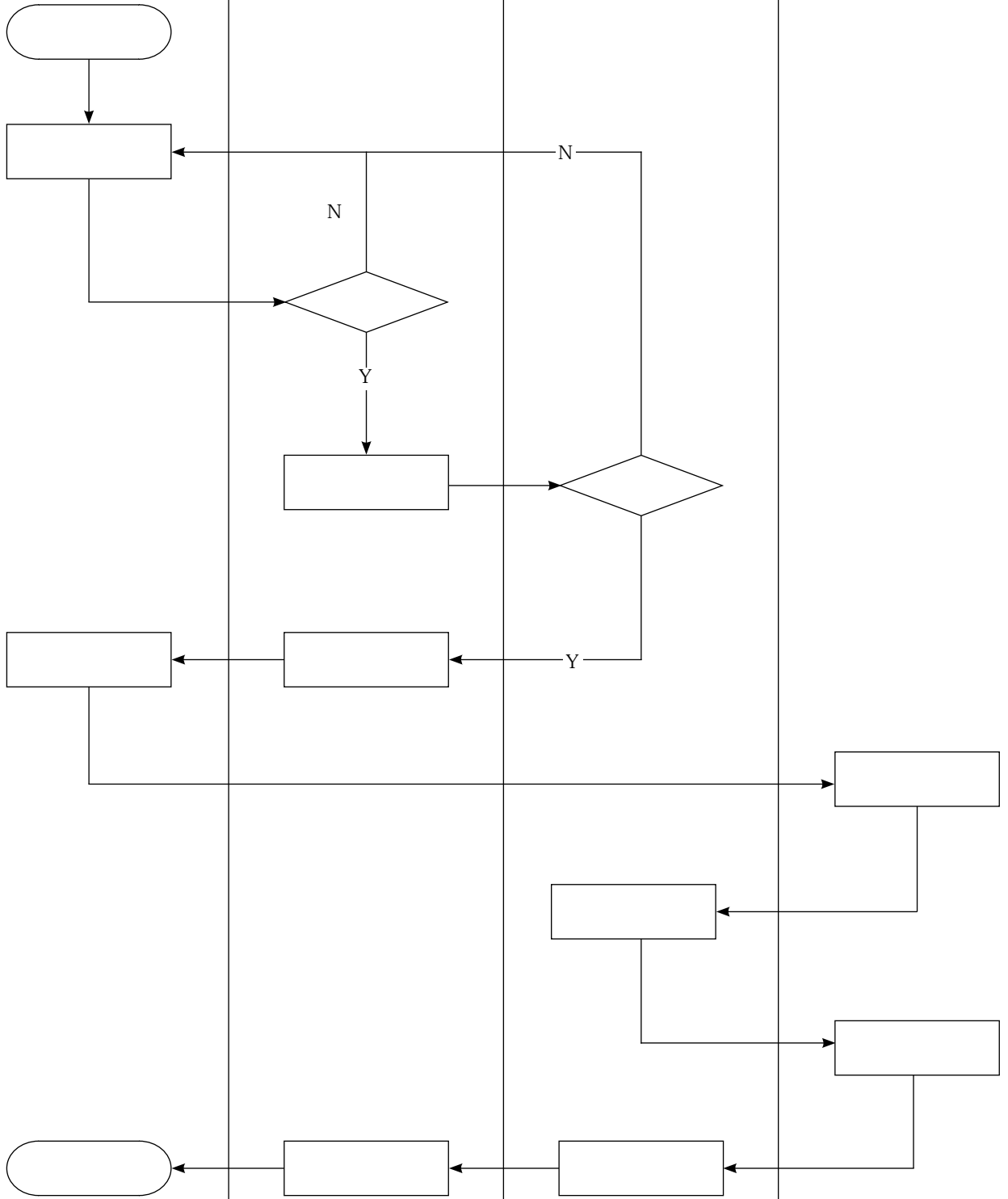

“

”

) +%

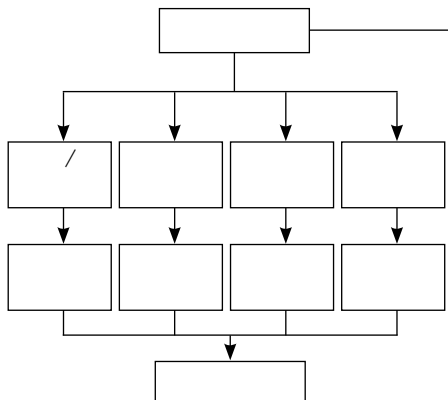
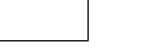
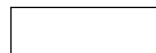
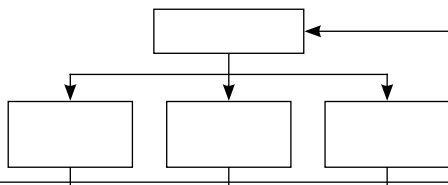
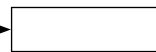
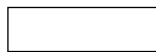
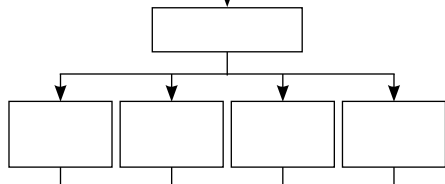
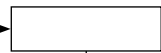
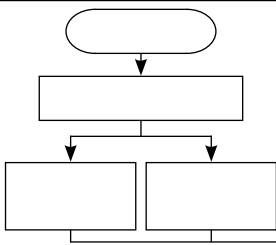

1
2

), %

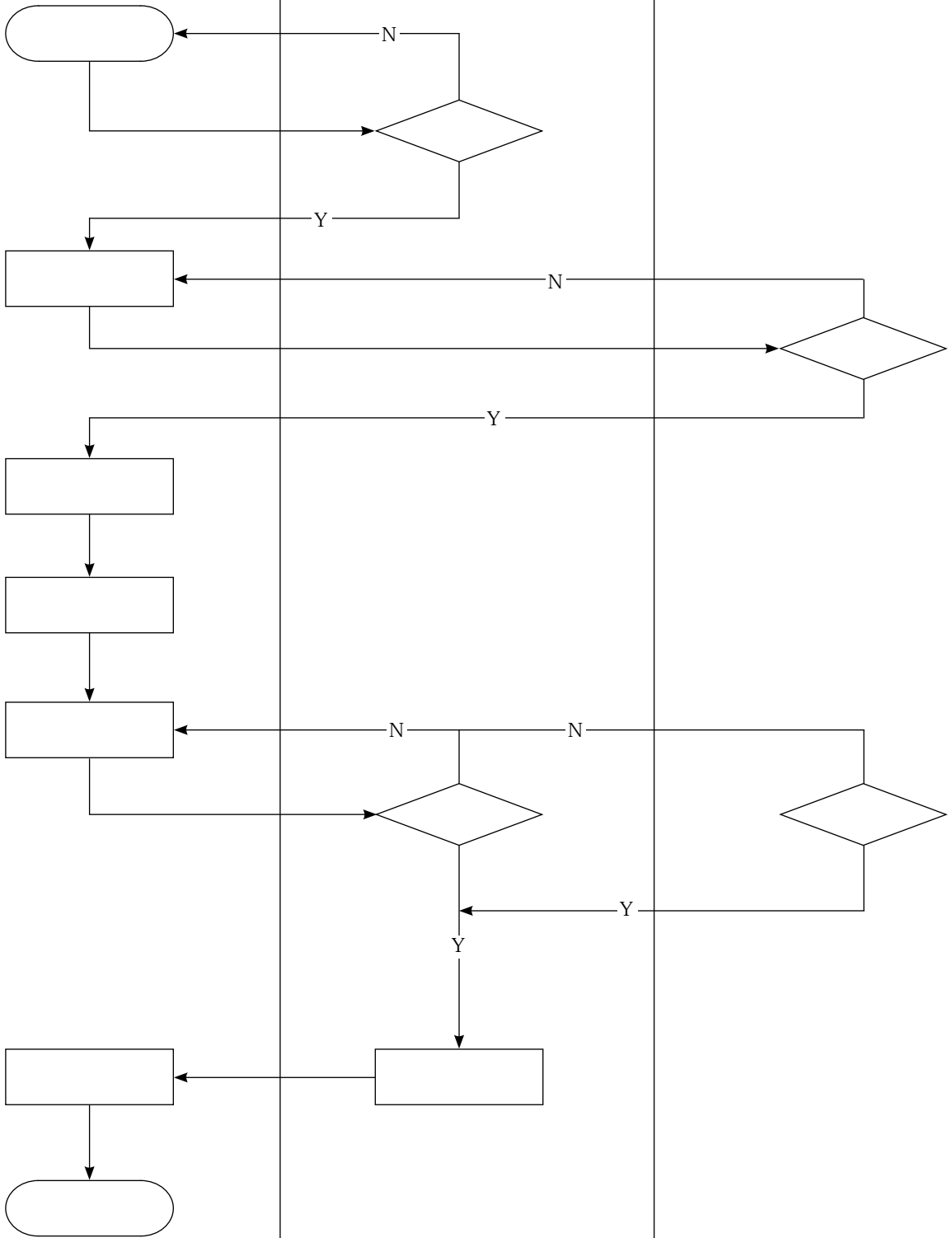

:

) - %

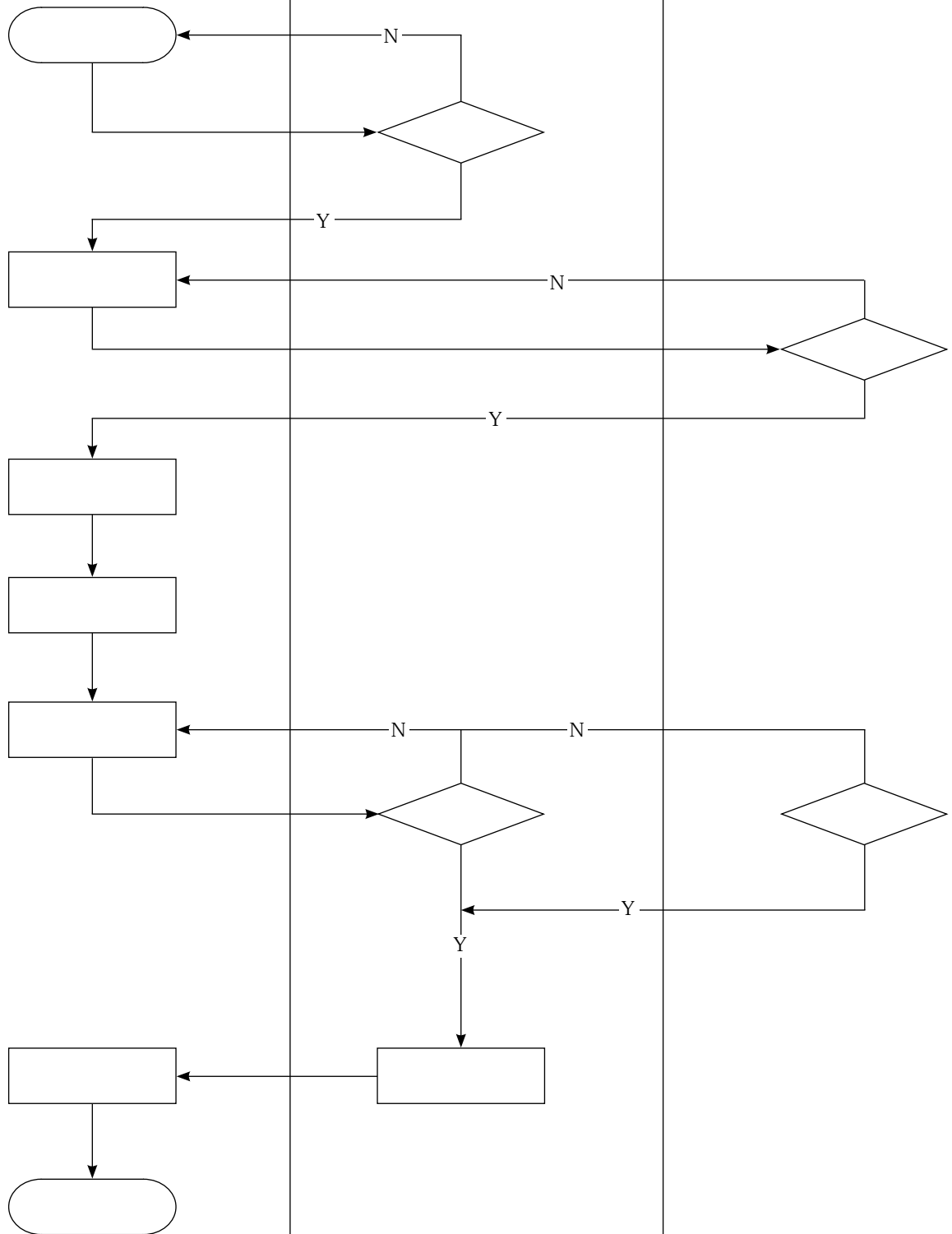

- 1.
- 2
- 3
- :

) . %

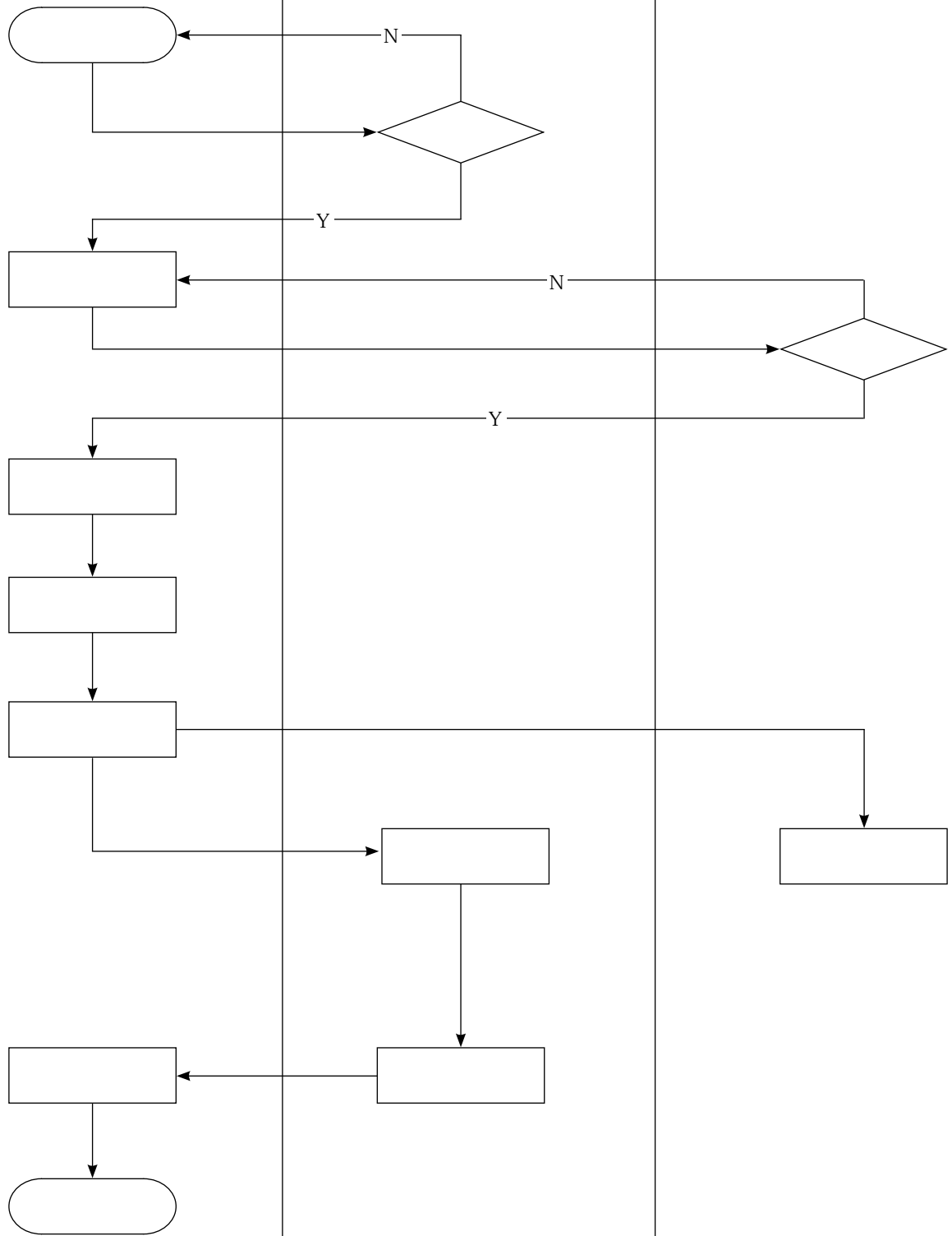

1.
2.
:

) / %

“ ”

